

# CUNEO STARKER

TRINCIA POLIVALENTE PESANTE | HEAVY DUTY MULTIPURPOSE MOWER



MOD : | 280 | 300 |

HH

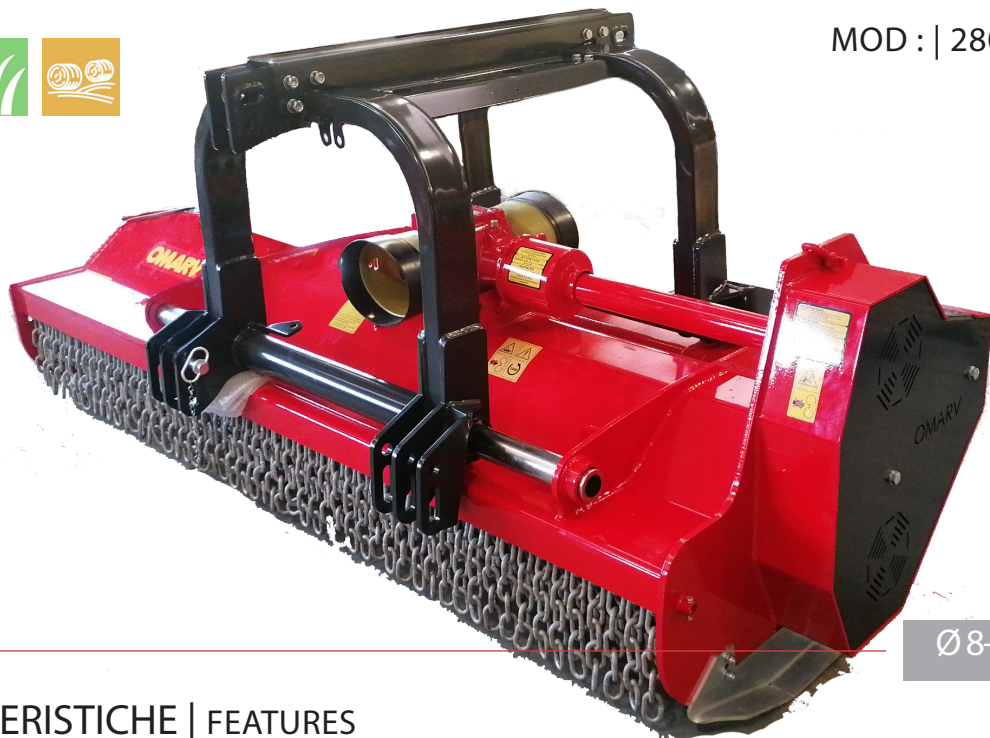

Ø8-12cm

## CARATTERISTICHE | FEATURES

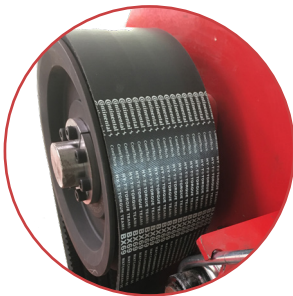

Monocinghia  
Monobelt

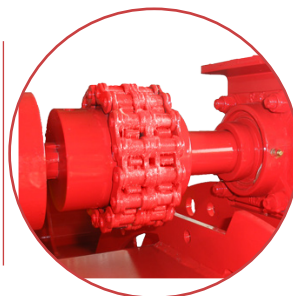

Giunto a catena  
Chain transmission



Catene parasassi  
Front protection Chains

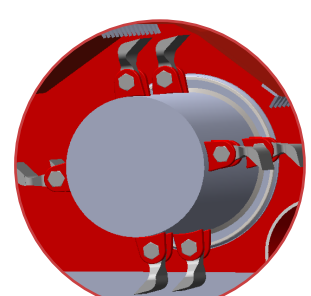

Rotore ø280mm  
ø280mm Rotor

- Attacco terzo punto: cat.2/3 | *Type attelage: cat.2/3*
- Rotore maggiorato ø280m | *ø280mm Bigger rotor*
- Trasmissione monocinghia 1x5 | *1x5 belt transmission*
- Tendicinghia automatico | *Automatic belt tightener*
- Scatola ingranaggi maggiorata | *Oversized gearbox*
- Giunto a catena | *Chain transmission*
- Catene parasassi frontali | *Front protection with chains*
- Doppio telaio | *Double chassis*
- Rullo smontabile con cuscinetti orientabili  
*Bolted roller with orientable bearings*
- Rullo autopulente | *Self-cleaning roller*
- Ingrassaggio centralizzato | *Centralised greasing system*
- Slitte laterali regolabili | *Adjustable side skids*

## ATTACCO TERZO PUNTO CAT 2/3 THREE POINT HITCH CAT 2/3

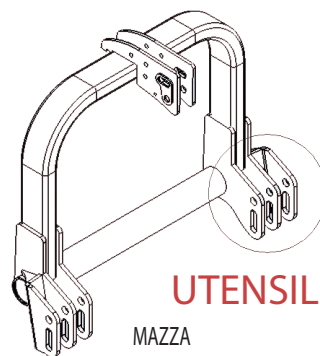



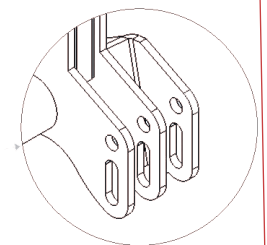



MAZZA  
HAMMER



COLTELLI A Y  
Y FLAILS



SPECIFICHE TECNICHE   TECHNICAL SPECIFICATIONS			
MODELLO   MODEL		280	300
	LARGHEZZA LAVORO WORK WIDTH (cm)	280	300
	LARGHEZZA MACCHINA WIDTH MACHINE (cm)	300	320
	PESO   WEIGHT	1470	1500
	N° MARTELLI e COLTELLI HAMMER and KNIFE	28   56	30   60
	N° CINGHIE SPBX BELTS SPBX	1 x 5	1 x 5
	SCATOLA MAGGIORATA OVERSIZED GEARBOX	140/240	140/240

OPZIONI & ACCESSORI   OPTIONS & ACCESSORIES	
CARDANO   PTO SHAFT (MOD: 280 to 300)	
CARDANO SPECIALE CON BULLONE DI SICUREZZA SPECIAL PTO SHAFT WITH SECURITY BOLT	



### Dettagli - Details

- Carter rinforzato saldato | Reinforced welded carter
- Rotore maggiorato  $\varnothing 280\text{mm}$  |  $\varnothing 280\text{mm}$  Bigger rotor

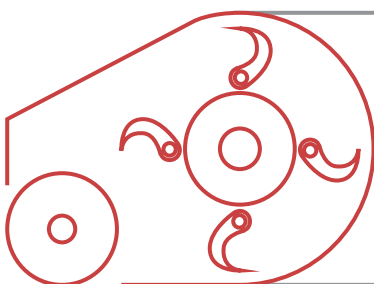

Ø del rotore   Ø of rotor	280 mm
Giri rotore   RPM	1850 g/min
Presenza di forza   PTO	1000
Ø del rullo   Ø of roller	220 mm